

This camera manual library is for reference and historical purposes, all rights reserved.

This page is copyright by mike@butkus.org M. Butkus, N.J.

**This page may not be sold or distributed without the expressed
permission of the producer**

I have no connection with any camera company

If you find this manual useful, how about a donation of \$3 to: M. Butkus, 29 Lake Ave., High Bridge, NJ 08829-1701 and send your E-mail address too so I can thank you. Most other places would charge you \$7.50 for a electronic copy or \$18.00 for a hard to read Xerox copy. These donations allow me to continue to buy new manuals and maintain these pages. It'll make you feel better, won't it?

If you use Pay Pal, use the link below. Use the above address for a check, M.O. or cash. Use the E-mail of butkusmi@ptd.net for PayPal.



[back to my "Orphancameras" manuals /flash and light meter site](#)

Only one "donation" needed per manual, not per multiple section of a manual !

The large manuals are split only for easy download size.

905 SWC

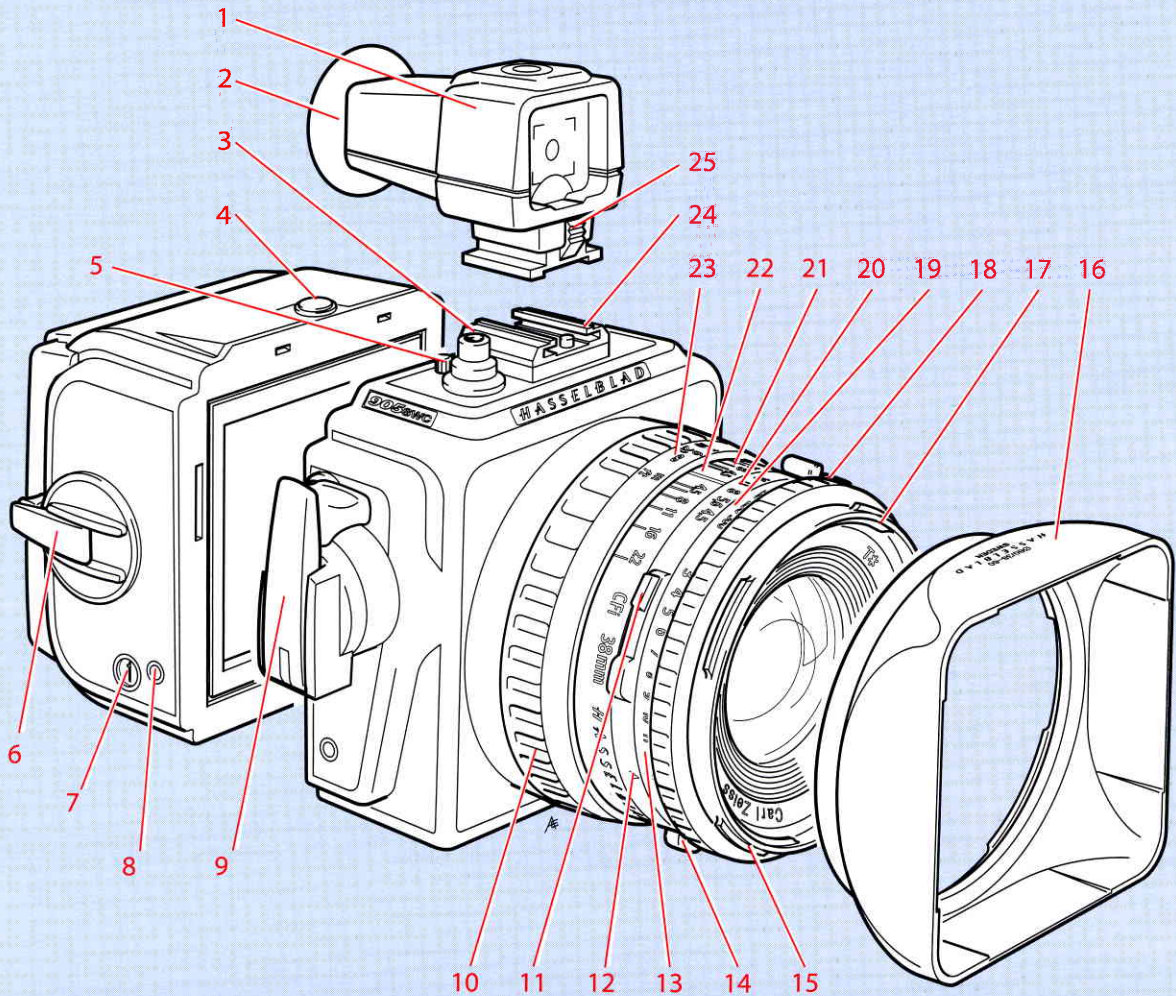

905 SWC

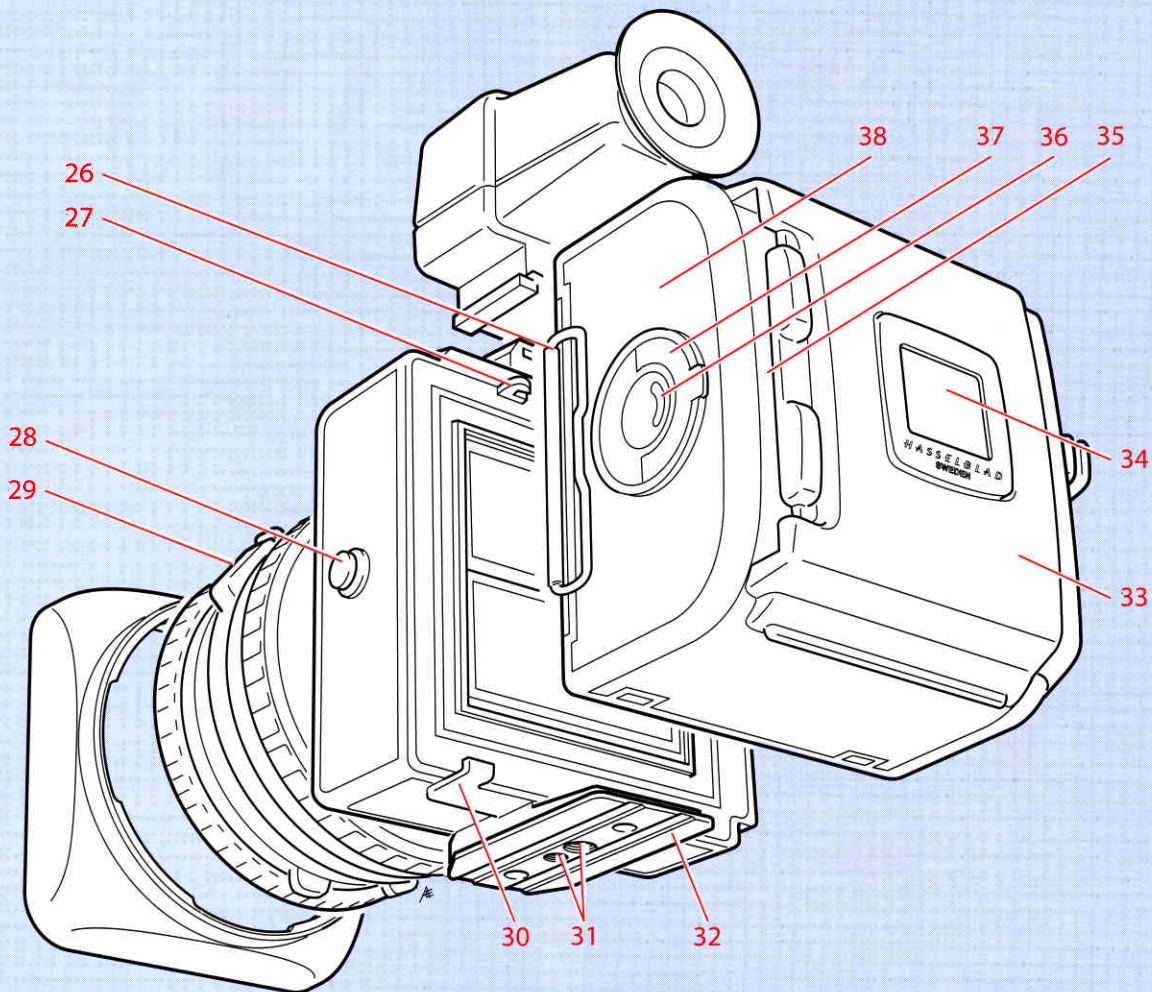

3

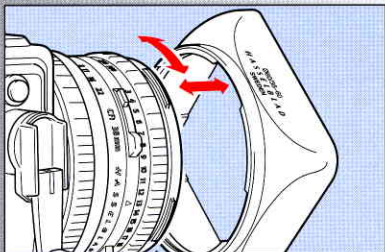

4

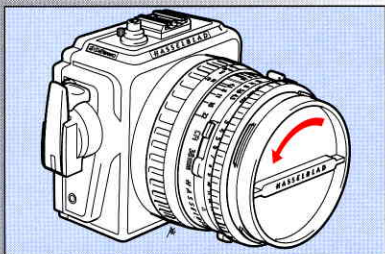

5

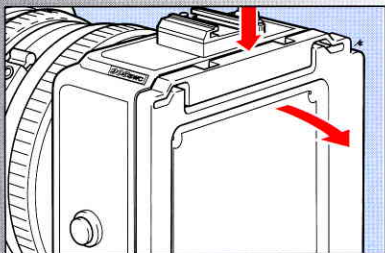

6

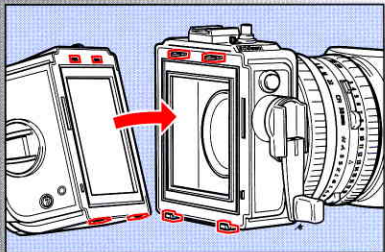

7

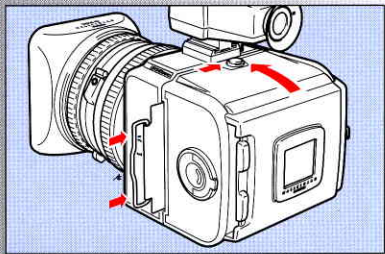

8

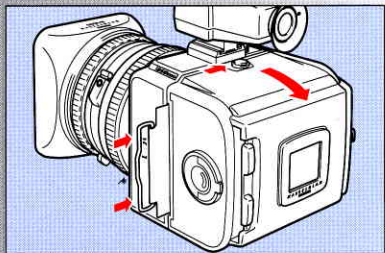

9

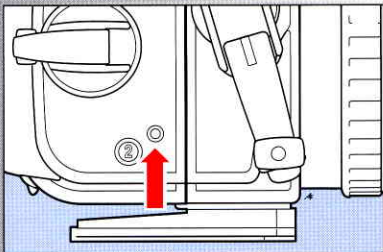

10

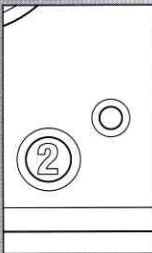

11

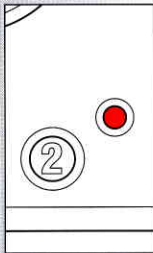

12

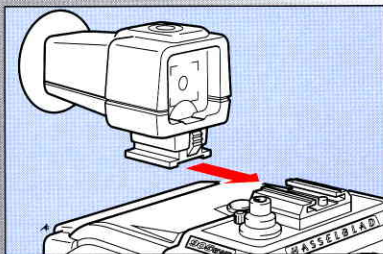

13

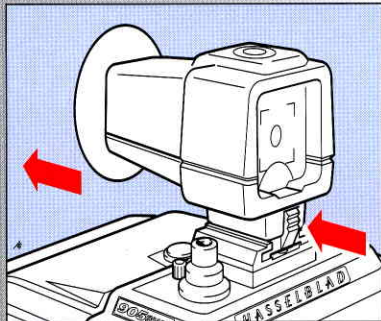

14

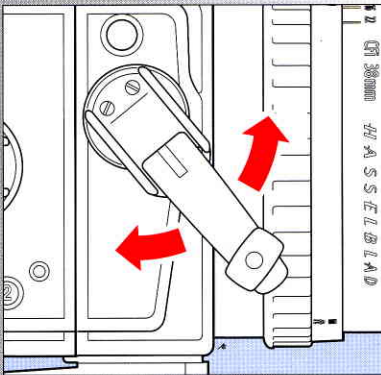

15

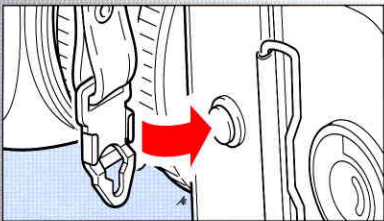

16

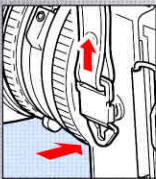

17

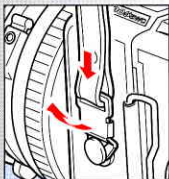

18



19

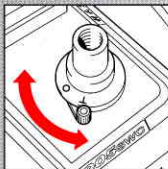

20

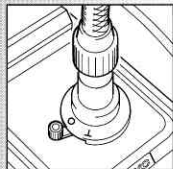

21

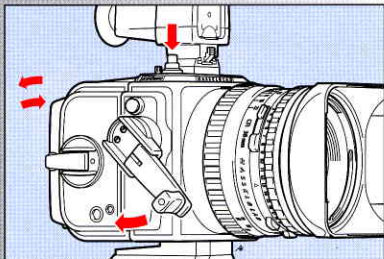

22

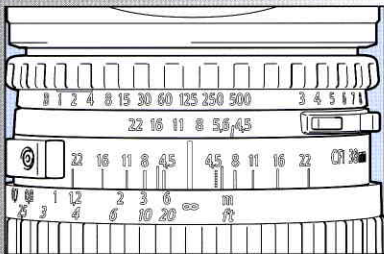

23

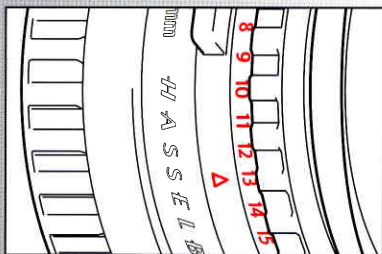

24

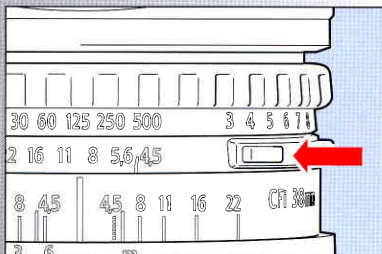

25

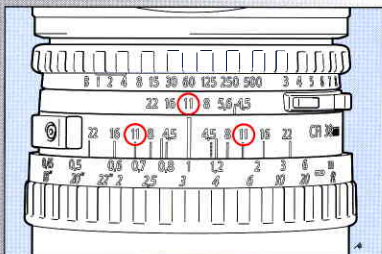

26

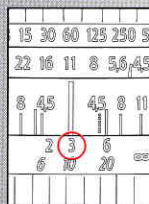

27



28

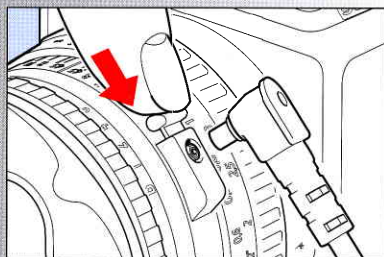

29

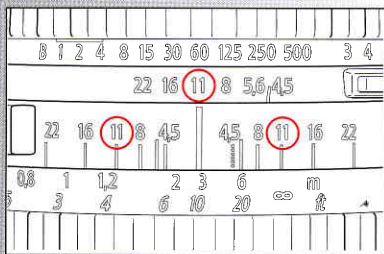

30

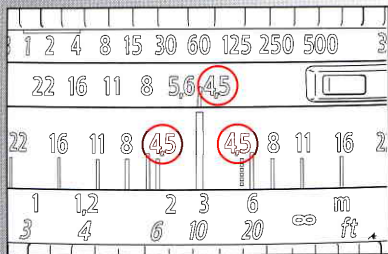

31

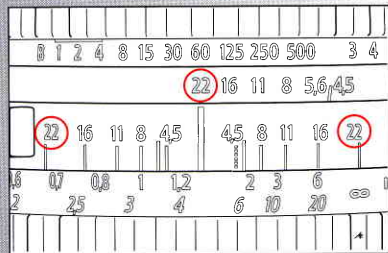

32

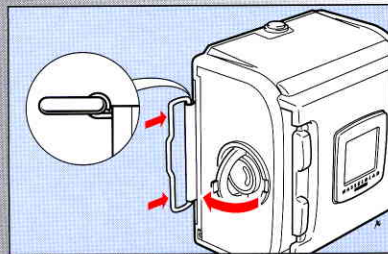

33

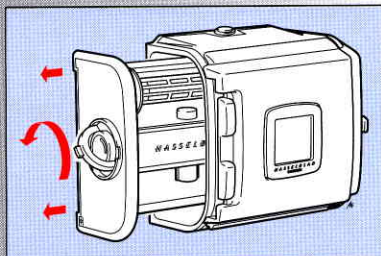

34

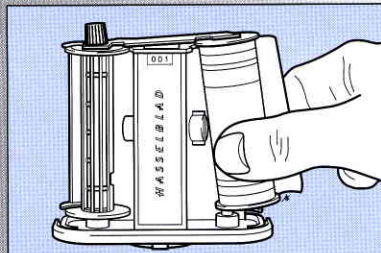

35

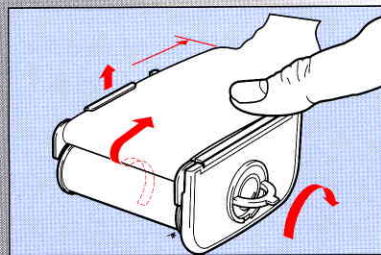

36

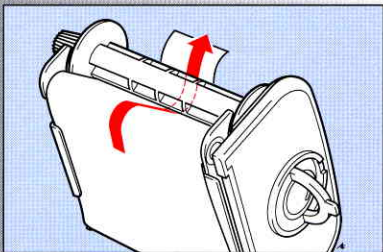

37

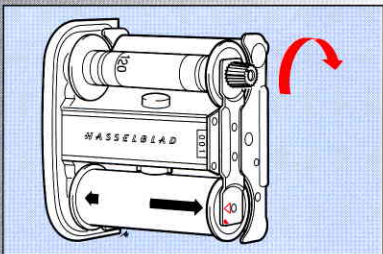

38

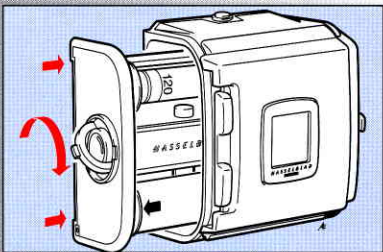

39

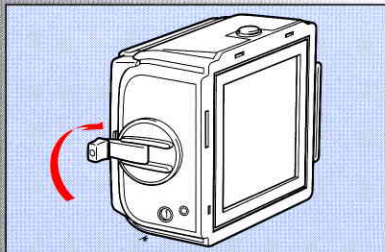

40

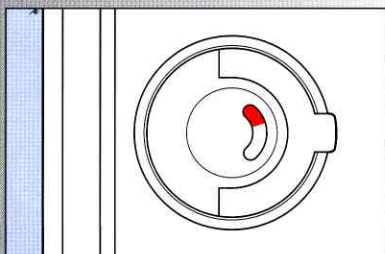

41

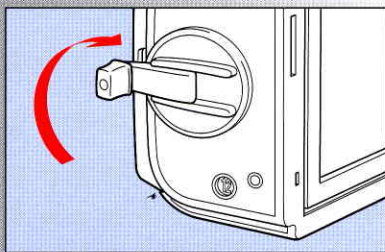

42

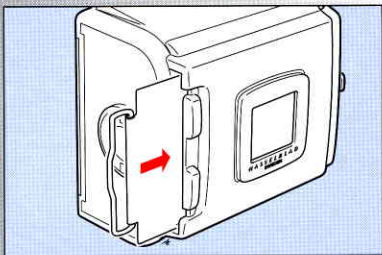

43

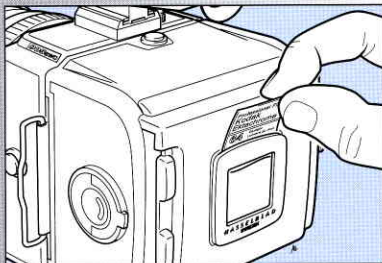

44

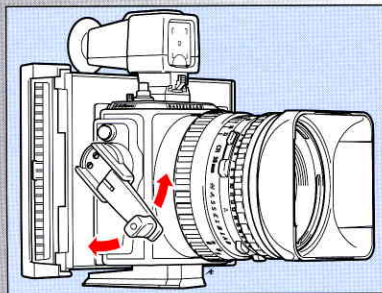

45

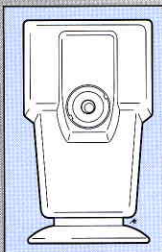

46

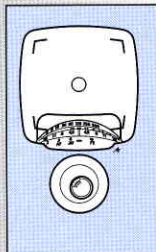

47

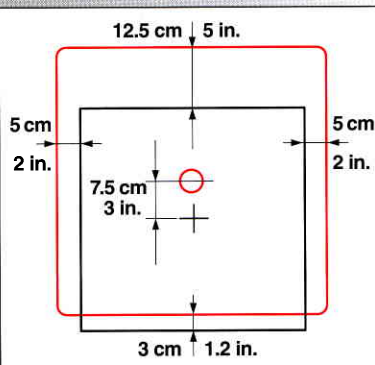

48

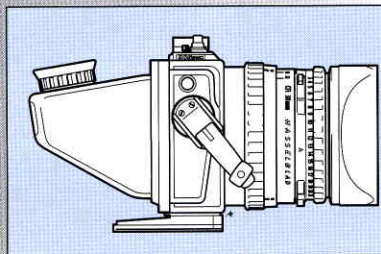

49

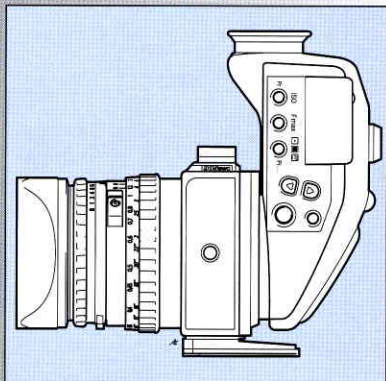

50

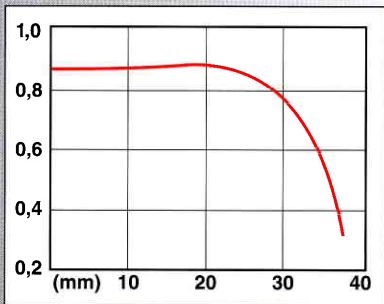

51

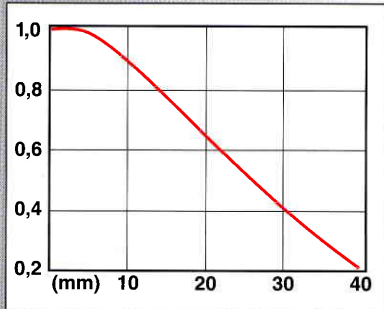

52

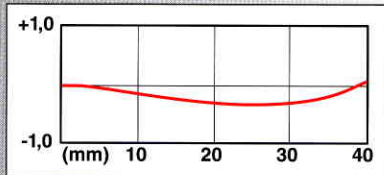

53

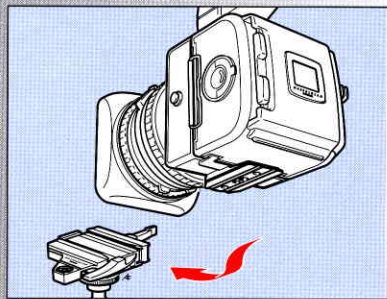



E12CC



E12



A12



E24



A24



E16



A16



70 mm



Pola



PME90



HM2



RMfx



PME45



PM90



PM45

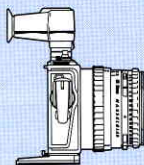

Proshade 6093T



Ø60



Ø60

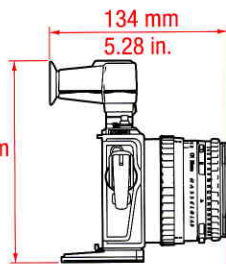
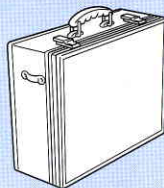
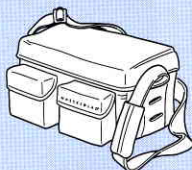
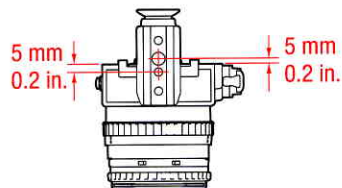
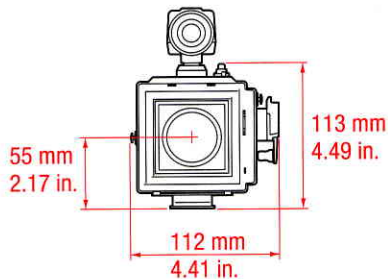

Ø60

153 mm
6.0 in.134 mm
5.28 in.126 mm
4.96 in.5 mm
0.2 in.5 mm
0.2 in.55 mm
2.17 in.113 mm
4.49 in.112 mm
4.41 in.